

AURA™

GOLF CART UNDERBODY

INSTALLATION GUIDE

MAIN COMPONENTS



LIGHT STRIPS

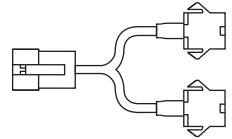

Y-SPLITTERS



AURA CONTROL BOX

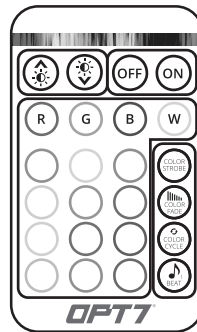

HAND HELD REMOTE

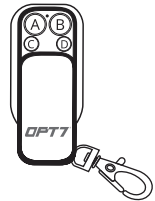

KEYCHAIN REMOTE



VARIOUS EXTENSION WIRES

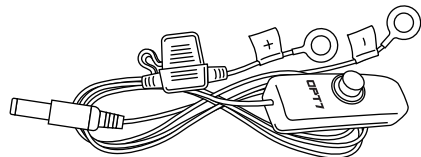

POWER HARNESS WITH ON/OFF SWITCH

INSTALLATION

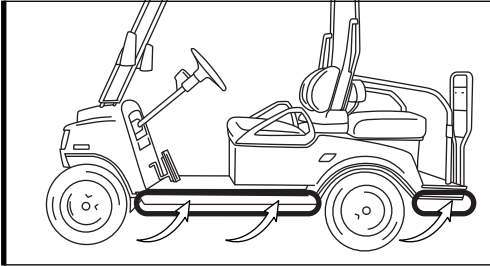

STEP 1

Decide where to locate the light strips and ensure wiring has enough length for control box to be installed in desired location.

EXAMPLES

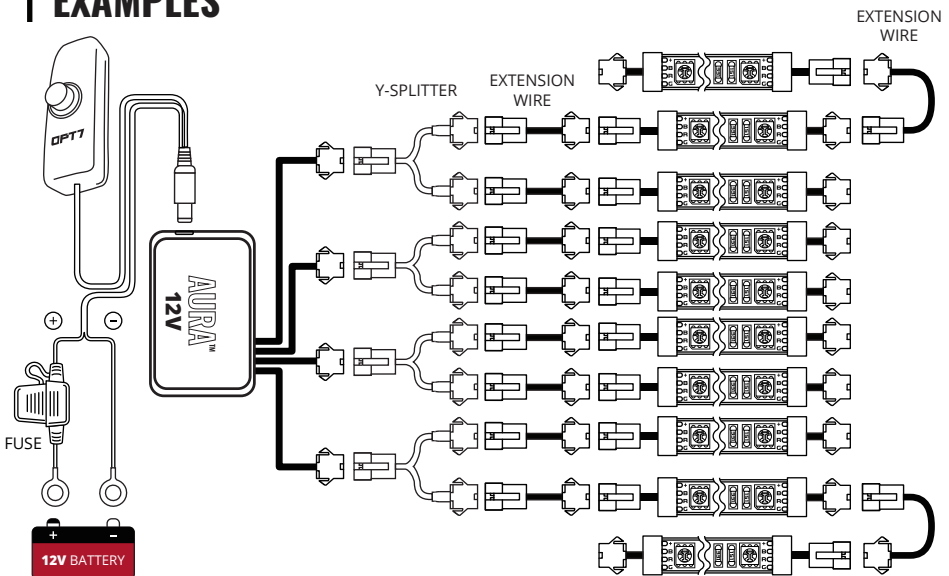

CAUTION! BEFORE YOU START

Connecting more than 6 AMP /12 V will override the kit and cause early failure, it must be power to a 6 AMP /12 V or less. You will need a voltage reducer if your battery is more than 12V.

We provide multiple sets of extension wires for you to configure. You may connect or customize to extend them wherever you want to install.

INSTALLATION

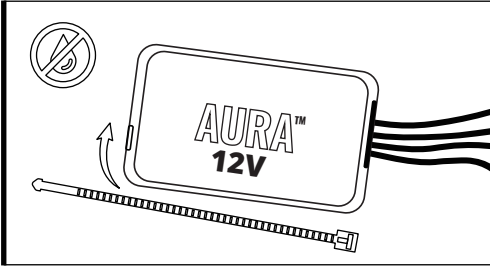

STEP 2

Secure Control box in desired location with Velcro or zip ties.

* CONTROL BOX NOT WATERPROOF
Ensure the control box is safely and securely hidden from exposing elements of moisture.

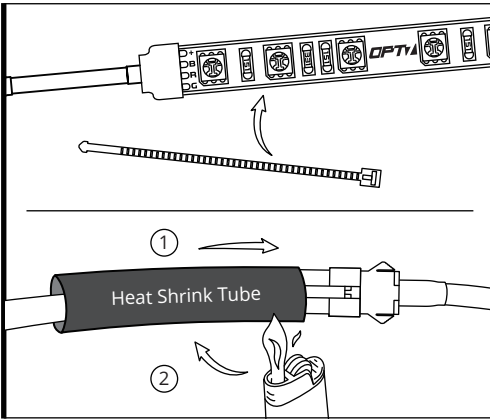

STEP 3

Secure the light strips using the zip ties to tie all the wiring away from the moving components.

* IMPORTANT:

The LED connectors are not waterproof. You will need to use HEAT SHRINK TUBE or ELECTRICAL TAPE around the LED connectors to ensure the longevity of the lighting kit.

STEP 4

Using the included E-Z Remote or Keychain Remote to select your desired color or pattern.

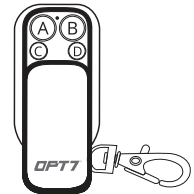
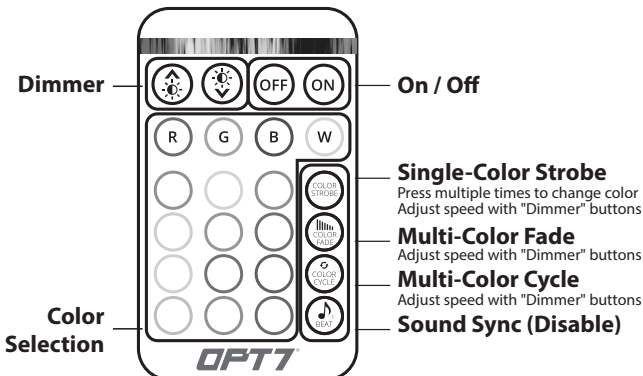

A ON/OFF

B Color Selector

Supports 16 sets of solid color changes

C Dimmer Up/Down

Supports 4 levels of brightness adjustment

D Disable (X)

OPTIONAL UPGRADE

Upgrade your Aura Original Control Box to the Aura Pro Bluetooth Control Box. All new AURA Pro Bluetooth is App enabled by a smartphone controller (iOS & Android Compatible).

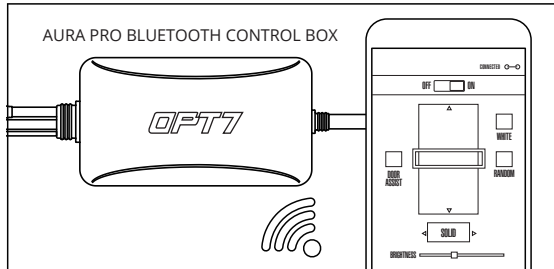

DISCLAIMER

OPT7 Lighting is not liable for damages or personal injuries while installing this product. The Installation Guide is intended as assistance to reduce setup time. OPT7 Lighting assumes no responsibility for improper installation.

If you are unfamiliar with your vehicle or inexperienced with aftermarket upgrades, please seek professional assistance.

OPT7 recommends installation for safety and guidance.

Modified installations or installation recommendations not specified by OPT7 Lighting will void product warranty.