

AURA™ GLOW DREAMCOLOR INTERIOR

6PC INSTALLATION GUIDE

MAIN COMPONENTS



LED LIGHT STRIPS

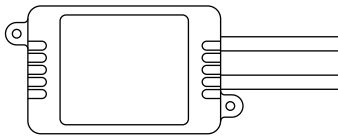

CONTROL BOX (SCAN QR CODE FOR APP USER GUIDE)

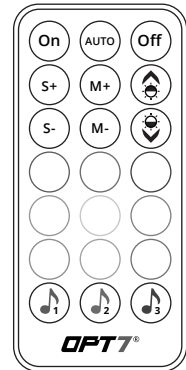

HAND HELD REMOTE



EXTENSION WIRES

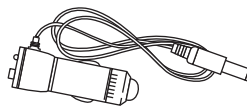

CIGARETTE LIGHTER POWER ADAPTER

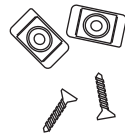

MOUNTING KIT

INSTALLATION

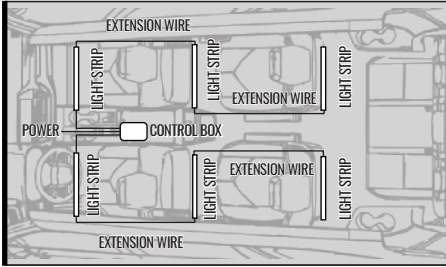

STEP 1

Decide where to locate the light strips and ensure wiring has enough length for control box to be installed in desired location.

As shown below, connect all light strips to the control box with the included extension cables.

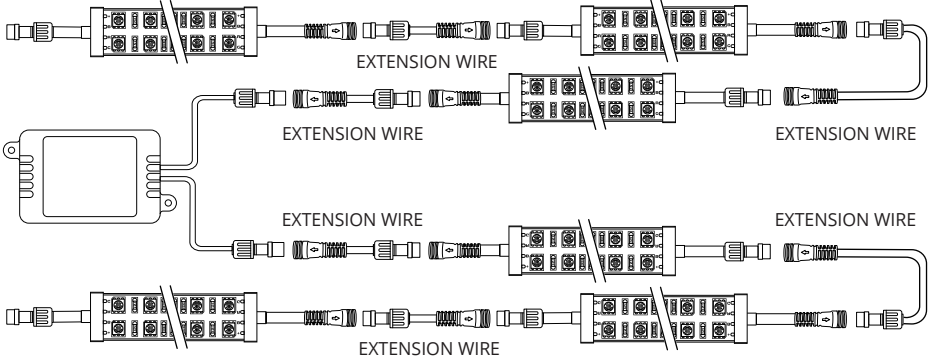

⚠ IMPORTANT ⚠

**BE SURE TO CONFIRM THE CORRECT DIRECTION OF THE ARROW!!
TO AVOID PRODUCT DAMAGE DUE TO INCORRECT INSTALLATION.**

Flow direction

Note the direction of the arrows

CORRECT INSTALLATION

Once connected, plug the control box Cigarette Power Adapter into an available 12 volt charging port.

12 VOLT CHARGING PORT



CIGARETTE POWER ADAPTER

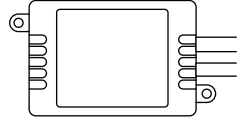
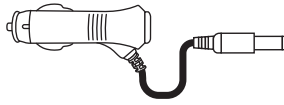

WARNING

1. Connecting to more than 10 AMP will override the kit and cause early failure, ensure it is 10 AMP or less!!
2. Please ensure that the LED bars or strips/control box/wiring all are mounted in areas where will not exceed 85°C or 185°F.

IMPORTANT

*Turning off the OPT7 GLOW completely helps avoid excessive battery consumption and extends the lifespan of the OPT7 light kits.

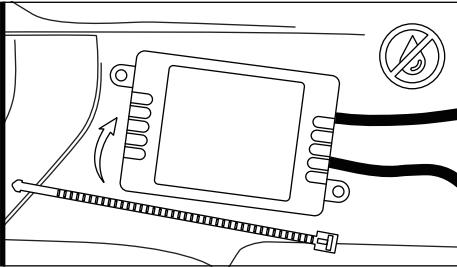

STEP 2

Secure Control box in desired location with Velcro or zip ties.

* CONTROL BOX NOT WATERPROOF
Ensure the control box is safely and securely hidden from exposing elements of moisture.

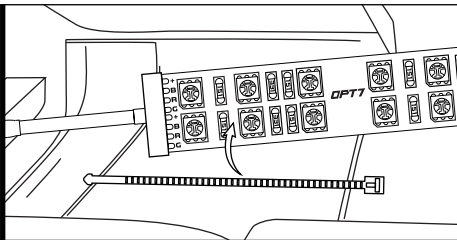

STEP 3

Thoroughly clean the surface where you plan on mounting the LED strip with rubbing / isopropyl alcohol. Tear o the 3M Double-sided tape and rmly press the LED strip to the mounting area and hold for 3 seconds.Then use the Zip-Ties to tie all wiring away from all moving components.

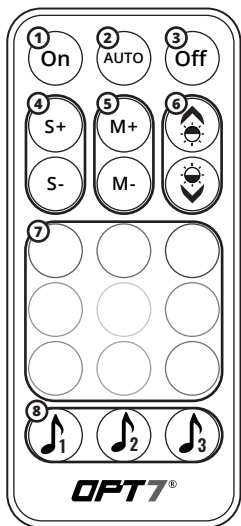

| STEP 4

Using the included 21Key E-Z Remote, select your desired color or pattern.

- 1 | Power-ON
- 2 | Automatic Color Change
- 3 | Power-OFF
- 4 | Speed +/- 10 Levels
- 5 | Mode +/- 24 Mode
- 6 | Dimmer 10 Levels
- 7 | Color Selection 9 Colors
- 8 | Sound Sync Color Selection 3 Colors

NOTE: When you use this product, keep it within 10m/33ft as much as possible.

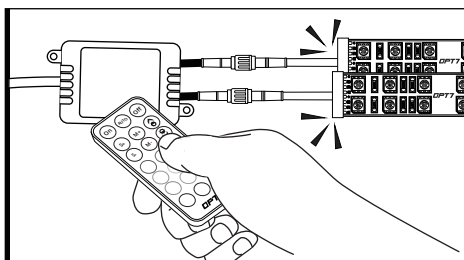

HOW TO PAIR THE REMOTE?

Pair the Device:

To pair the remote, reconnect the power, then aim the remote at the control box and hold the ON button until the LED strips flash white.

Unpair the Device:

To unpair the remote, reconnect the power, then aim the remote at the control box and hold the OFF button until the LED strips flash white.

QR CODE TO DOWNLOAD



SCAN FOR APP

OPT7®
GLOW



Download the free "OPT7 GLOW" App

- App iOS (12+) available on App Store
- Android (8+) available on Google Play

| STEP 6

Download the OPT7 GLOW to have the best experience.



Please scan to see the OPT7 GLOW user guide.

<https://wintis.ladesk.com/362302-OPT7-AURA-Glow-Application-User-Guide>

DISCLAIMER

OPT7 Lighting is not liable for damages or personal injuries while installing this product. The Installation Guide is intended as assistance to reduce setup time. OPT7 Lighting assumes no responsibility for improper installation. If you are unfamiliar with your vehicle or inexperienced with aftermarket upgrades, please seek professional assistance.

OPT7 recommends installation for safety and guidance.

Modified installations or installation recommendations not specified by OPT7 Lighting will void product warranty.