

AURA™ PRO

DRL HALO RGB DODGE CHALLENGER 08-23

BLUETOOTH OPT7 GLOW APP & REMOTED CONTROLLED

COMPONENTS



LED LIGHT STRIPS



EXTENSION WIRES

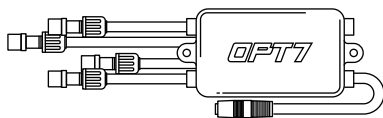

AURA Control Box (SCAN QR CODE FOR APP USER GUIDE)

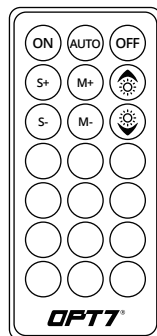

HAND HELD REMOTE

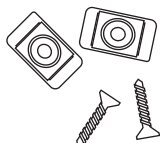

MOUNTING KIT

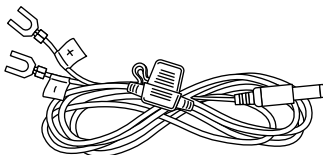

HARDWIRE POWER HARNESS



ZIP TIES

INSTALLATION

STEP 1



Open the hood.

STEP 2

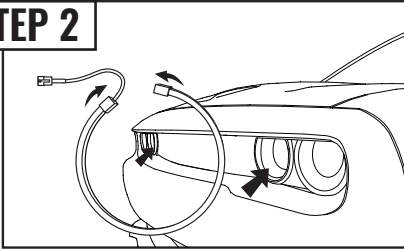

Wrap the LED strip into a circle shape and firmly press into place inside of the intake hole to secure.

AND/OR

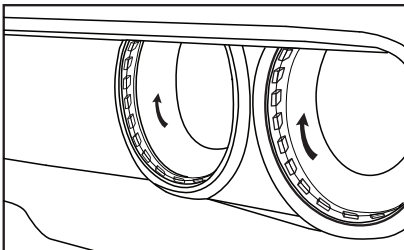

Attach the strip as pictured as an alternate method of install.

STEP 3

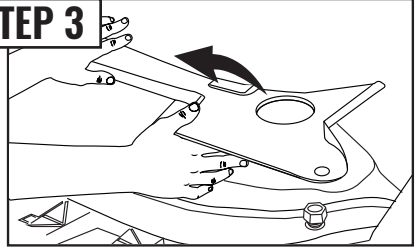

Remove the plastic covers on the right and left side of the engine bay.

STEP 4

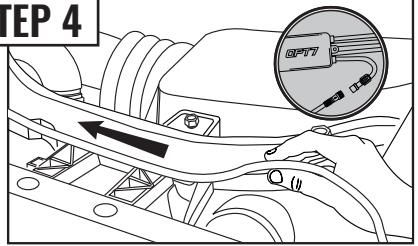

Run the wires along the front brace and connect to the control box.

STEP 5

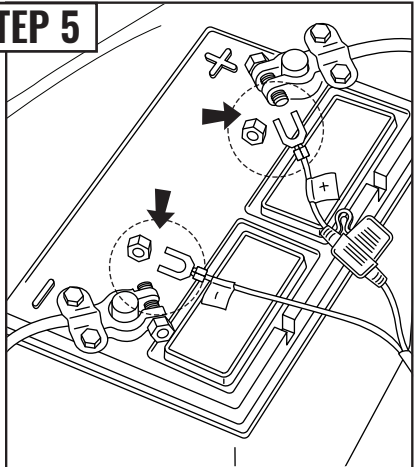

Connect the power wire harness to your vehicle battery.

INSTALLATION

⚠ IMPORTANT ⚠

**BE SURE TO CONFIRM THE CORRECT DIRECTION OF THE ARROW!!
TO AVOID PRODUCT DAMAGE DUE TO INCORRECT INSTALLATION.**

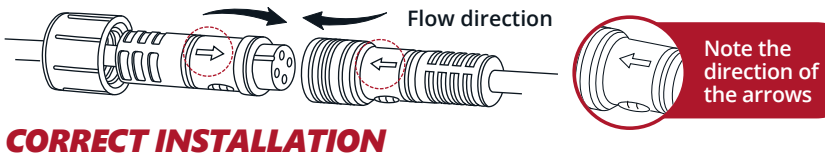

As shown below, connect all the LED bars to the control box with the included extension cables.

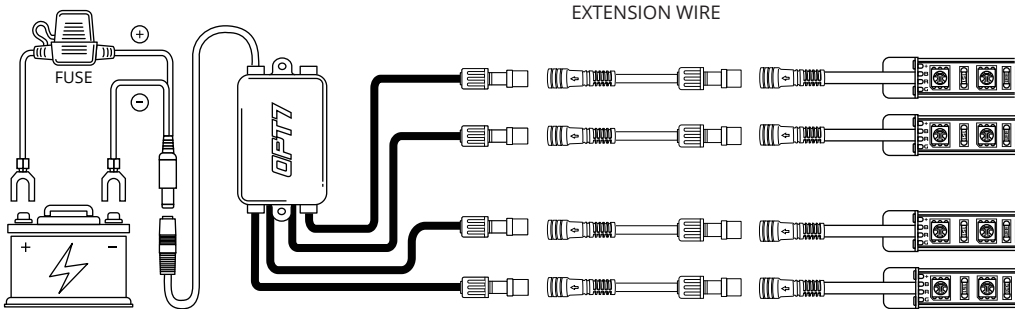

WARNING

1. Connecting to more than 10 AMP will override the kit and cause early failure, ensure it is 10AMPs or less!!
2. Please ensure that the LED bars or strips/control box/wiring all are mounted in areas where will not exceed 85°C or 185°F.

IMPORTANT

*Turning off the OPT7 GLOW completely helps avoid excessive battery consumption and extends the lifespan of the OPT7 light kits.

INSTALLATION

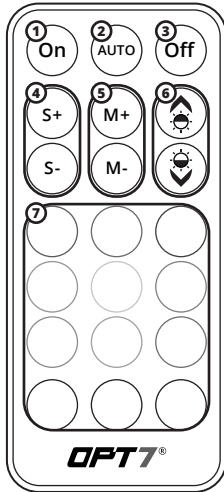

| STEP 6

Using the included 21Key E-Z Remote, select your desired color or pattern.

- 1 | Power-ON
- 2 | Automatic Color Change
- 3 | Power-OFF
- 4 | Speed +/- 10 evels
- 5 | Mode +/- 24 Mode
- 6 | Dimmer 10 Levels
- 7 | Color Selection 12 Colors

NOTE: When you use this product, keep it within 10m/33ft as much as possible.

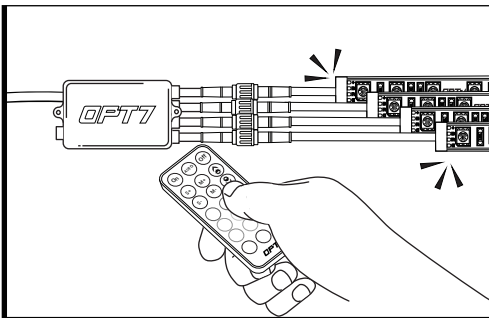

HOW TO PAIR THE REMOTE?

Pair the Device:

To pair the remote, reconnect the power, then aim the remote at the control box and hold the ON button until the LED strips flash white.

Unpair the Device:

To unpair the remote, reconnect the power, then aim the remote at the control box and hold the OFF button until the LED strips flash white.

INSTALLATION

QR CODE TO DOWNLOAD



Download the free "OPT7 GLOW" App

- App iOS (12+) available on App Store
- Android (8+) available on Google Play

| STEP 7

Download the OPT7 GLOW to have the best experience.



Please scan to see the OPT7 GLOW user guide.

<https://wintis.ladesk.com/362302-OPT7-AURA-Glow-Application-User-Guide>

| DISCLAIMER

OPT7 Lighting is not liable for damages or personal injuries while installing this product. The Installation Guide is intended as assistance to reduce setup time. OPT7 Lighting assumes no responsibility for improper installation. If you are unfamiliar with your vehicle or inexperienced with aftermarket upgrades, please seek professional assistance.

OPT7 recommends installation for safety and guidance.

Modified installations or installation recommendations not specified by OPT7 Lighting will void product warranty.