

# AURA™ PRO V2

## INTERIOR NAVI INSTALLATION GUIDE

### COMPONENTS



LIGHT STRIPS



MOUNTING KIT

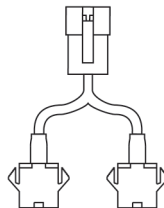

Y-SPLITTERS



AURA BLUETOOTH CONTROL BOX

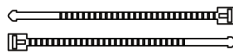

ZIPTIES



HARDWIRE POWER HARNESS



EXTENSION WIRES

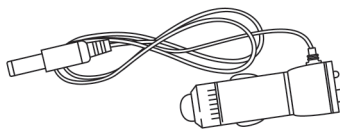

CIGARETTE LIGHTER POWER SUPPLY

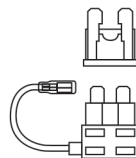

FUSE TAPS

# INSTALLATION

## STEP 1

Inspect the kit has all the contents included and power the unit to test the lights function properly with the 12 volt adapter provided.

## STEP 2

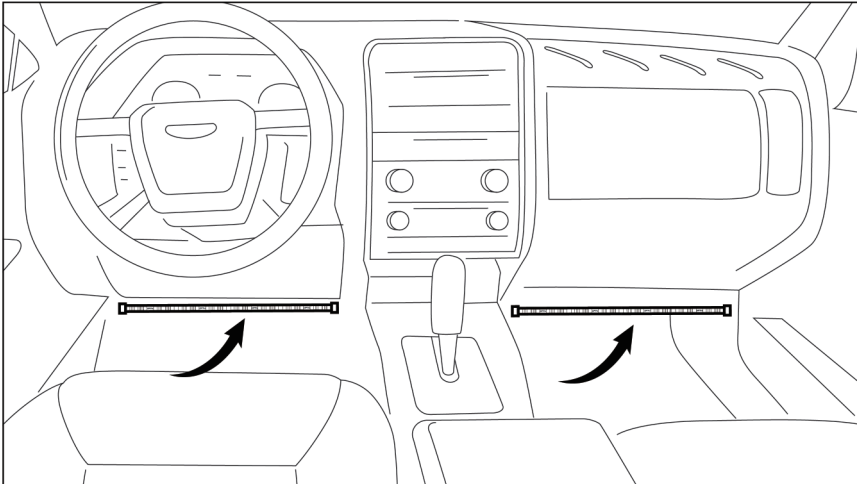

Locate the control box L - Left and R - Right. Decide where to locate the light strips (as shown as figure 1.1). Ensure the wirings are enough length for the control box to be installed in your desired location.

**NOTE:** This kit provides a "NAVIGATION" feature in the OPT7 Connect App. In order to be able to use the function and work properly, we must require you to follow the instructions for the construction. This will prevent you from getting the wrong light signals after you start the install.

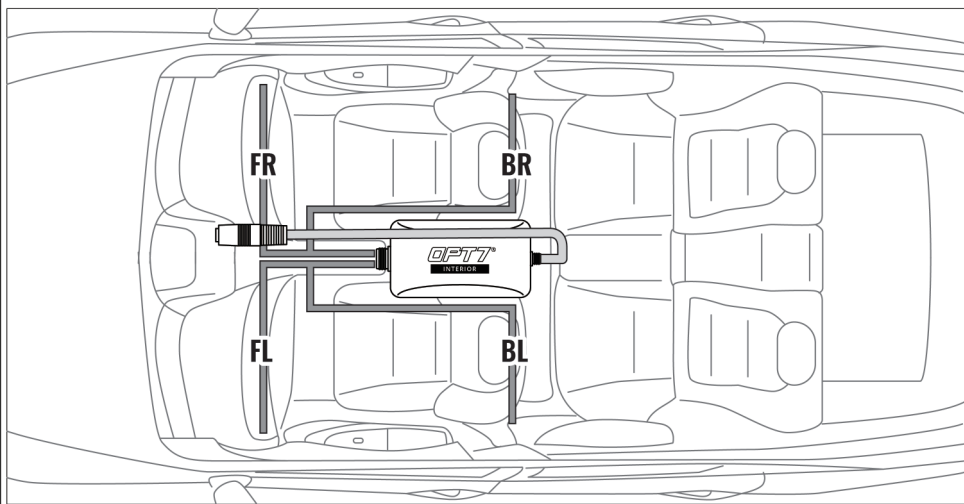

FL- FRONT LEFT | FR- FRONT RIGHT | BL- BACK LEFT | BR- BACK RIGHT

FIG.1.1

## OPTION A

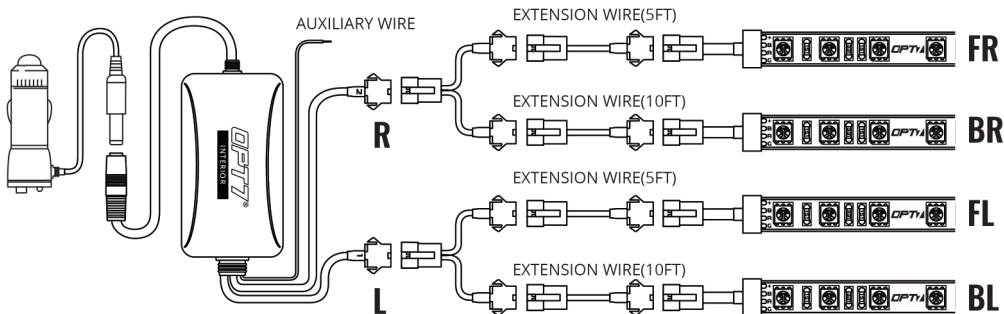

## OPTION B

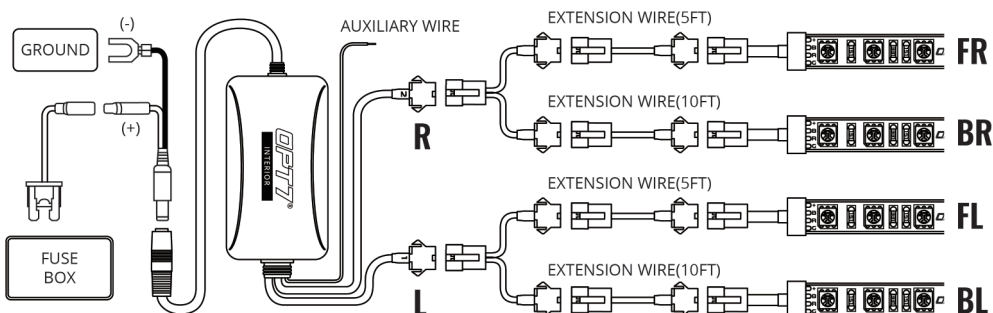



### | STEP 3

Scan the QR code on the back of the control box to download the app.

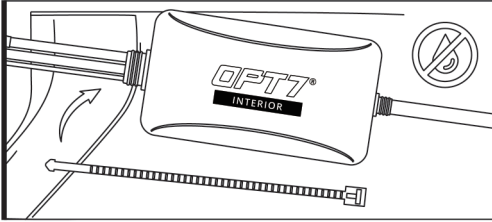

### | STEP 4

Secure Control box in desired location with Velcro or zipties.

\* **The control box is NOT waterproof. Tuck it away from the elements.**

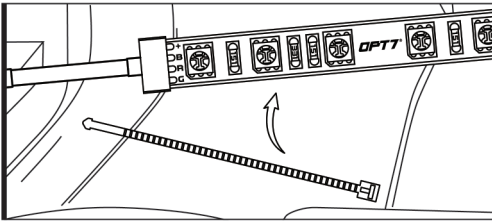

### | STEP 5

Use the included zipties to tie all wiring away from all moving components.

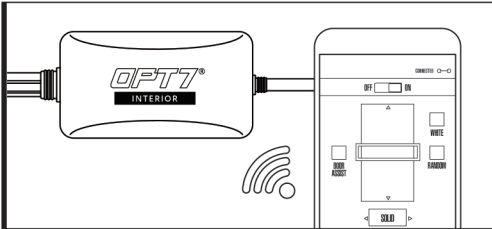

### | STEP 6

Open the **OPT7 Connect** App, pair your smart **phone** to the control box and pick your desired color.



For the App Guide, you can scan QR code or go to the link below to read a more detailed description.

<https://support.opt-7.com/459384-PRO-V2-Interior-Only>

## | AUX WIRING FOR A DOOR/DOME LIGHT



Please scan to see a detail instruction on Door Assist Sync or go to

<https://wintis.ladesk.com/549690-AURA-Door-AssistAUX-Installation-Guide>



## | OPT7 CONNECT APP

- Colors
- Modes
- Door Assist
- Support
- Ability to control up to 4 devices at once

## QR CODE TO DOWNLOAD



Download the free "OPT7 CONNECT" App

- App iOS (12+) available on App Store
- Android (6 +) available on Google Play

## | DISCLAIMER

OPT7 Lighting is not liable for damages or personal injuries while installing this product. The Installation Guide is intended as assistance to reduce setup time. OPT7 Lighting assumes no responsibility for improper installation. If you are unfamiliar with your vehicle or inexperienced with aftermarket upgrades, please seek professional assistance.

OPT7 recommends installation for safety and guidance.  
Modified installations or installation recommendations not specified by OPT7 Lighting will void product warranty.

## NAVIGATION WARNINGS!

The Aura navigation feature is ONLY authorized for the Aura INTERIOR product line only. Using this feature on any external aura product while driving may cause serious safety risks to yourself and other drivers around you.

NOTE: The driver alerts and speed limit features are for information only and you must obey all the announced speed limit signs and use safe driving judgment. OPT7 is not responsible for any traffic fines or citations you receive for falling to follow all applicable traffic laws and signs.

GETTING STARTED WITH

***OPT7<sup>®</sup>***

**CONNECT**

We provide a free APP for you to download to your smartphone.  
The following guide, you will be able to fully experience the application of these features. Now let's get started....

**PLEASE READ THIS INSTRUCTION MANUAL CAREFULLY BEFORE USING THIS PRODUCT.**

## | USER INTERFACE OVERVIEW

You can confirm the main elements of the user interface with the following illustrations.

- 1 CONNECT**  
Scan all available devices.
- 2 SORT**  
Rescan all devices.
- 3 RENAME YOUR DEVICE**  
Modify the naming of connected devices.
- 4 0 OF 6**  
Number of currently connected devices.
- 5 PRODUCT MODEL**  
Device name.
- 6 DESELECT ALL**  
Clear all connected devices.
- 7 NEXT**  
Proceed to the next page.

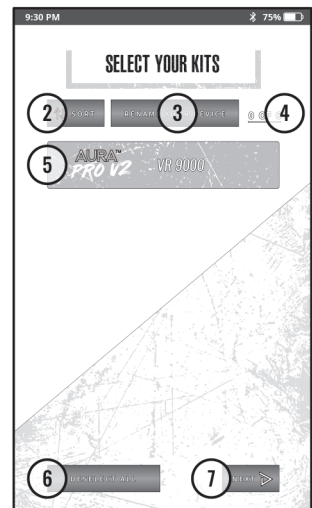
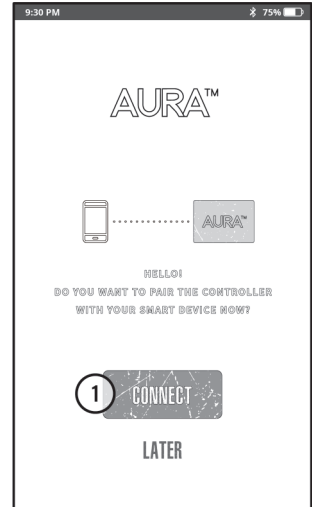

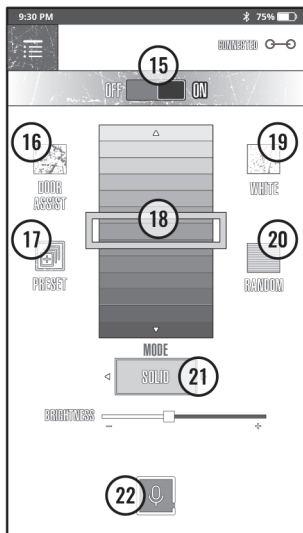
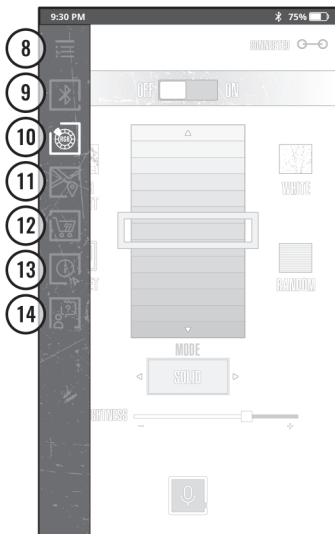

## 8 MAIN MENU

Main function list

## 9 DEVICE CONNECTION

## 10 COLOR PALETTE

## 11 NAVIGATION

## 12 AURA STORE

## 13 OPT7 SUPPORT

## 14 LIVE CHAT

## 15 ON/OFF

Turn ON/OFF the lights

## 16 DOOR ASSIST

Only supports "Solid" color setting

## 17 PRESET

Allows 3 sets of customized color settings

## 18 COLOR PICKER

Supports 64 color mode

## 19 WHITE

Switch to white light mode

## 20 RANDOM

Random color generator

## 21 STYLE MODE

- Swipe ScrollWheel horizontally to set the desired mode.
- **Solid** Adjustable Brightness
- **Strobe** Adjustable Brightness/ Speed
- **Color fade** Adjustable Speed
- **Cycle** Adjustable Brightness/Speed
- **Sound SYNC** Adjustable Sensitivity

## 22 VOICE CONTROL

See note 1 below

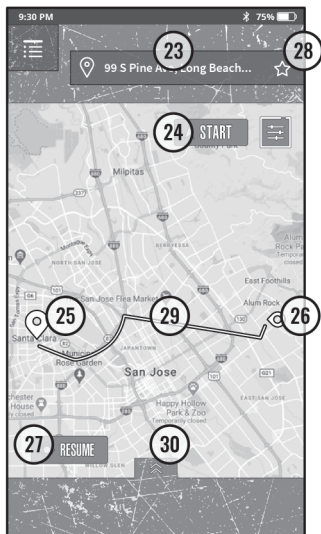

## 23 SEARCH BAR

Enter your destination

## 24 START

Start a route to any destination

## 25 DESTINATION

## 26 START POINT

## 27 RESUME

Resume your location

## 28 RECORD & DELETE

x Delete

☆ Add a place to your favorite

★ Favorite place

## 29 TURN-BY-TURN NAVIGATION

## 30 RECENT & FAVORITE

## 31 ROUTE DISPLAY

## 32 SPEED LIMIT

## 33 TRAVEL TIME & DISTANCE

## 34 LIGHT SETTINGS

## 35 SOUND

Turn ON/OFF voice guidance

## 36 ETA

Estimated time of arrival

## 37 CONTINUE & STOP NAVIGATION

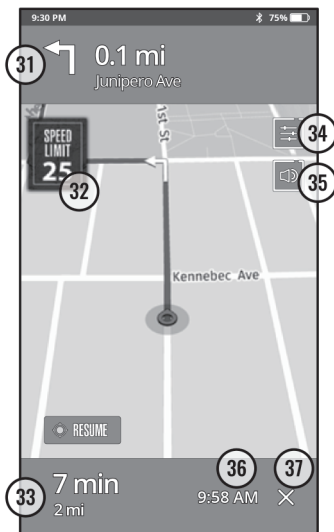

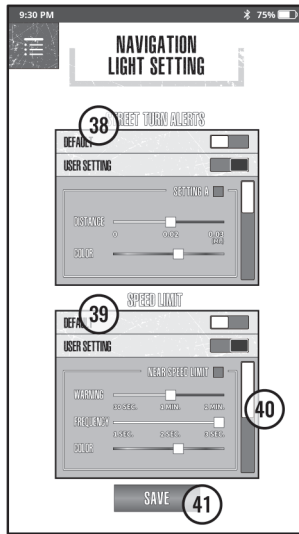

### 38 STREET TURN ALERTS

There are two options to set the feature

- **DEFAULT / USER SETTING**

When the slider lights up in “Red”, this setting will be enabled.

- **DISTANCE** To adjust the turn alerts level
- **COLOR** Select your favorite as a reminder

### 39 SPEED LIMIT

There are two options to set the feature

- **DEFAULT / USER SETTING**

When the slider lights up in “Red”, this setting will be enabled.

- **WARNING** Adjustable reminder time
- **FREQUENCY** Adjustable flash level
- **COLOR** Select your favorite as a reminder

### 40 SCROLLBAR

### 41 SAVE

## NOTE 1: HOW TO USE VOICE TO CONTROL YOUR LIGHTS?

First, you need to activate the microphone icon , and then immediately make your request. A list of them follows below.

Press the microphone button and say one of the following commands:

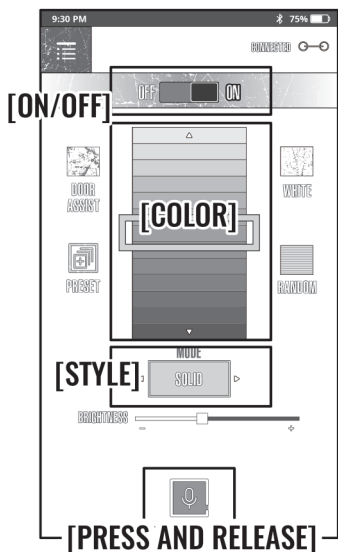

### [ON/OFF]

Specifies an action as a command. Example "Turn ON The Light".

### [STYLE]

Specifies a style as a change command. Example "Change To Strobe".

### [COLOR]

Specifies a color as a change command. It must contain the keywords "Change color and Color name". Example "Change Color To Blue".

#### IMPORTANT:

To make it easier for the voice control to recognize your phrase/word as a command, please try to use it in an environment with less background noise interference.

NO#	Color#	NO#	Color#	NO#	Color#
#1	Red	#12	Light Sea Green	#23	Purple
#2	Orange Red	#13	Teal	#24	Violet
#3	Dark Orange	#14	Aqua	#25	Magenta
#4	Orange	#15	Aqua Marine	#26	Orchid
#5	Gold	#16	Deep Sky Blue	#27	Medium Violet
#6	Yellow	#17	Sky Blue	#28	Deep Pink
#7	Lawn Green	#18	Blue	#29	Hot Pink
#8	Yellow Green	#19	Royal Blue	#30	Fuchsia
#9	Green	#20	Medium Purple	#31	Pink
#10	Spring Green	#21	Dark Magenta	#32	White
#11	Sea Green	#22	Medium Orchid		

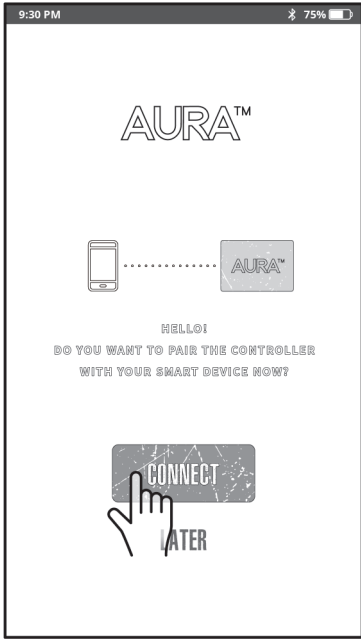

## STEP 1 SCANNING DEVICE

Open the APP and tap "CONNECT". Next, you will be directed to the main page for the Bluetooth pairing of the device.

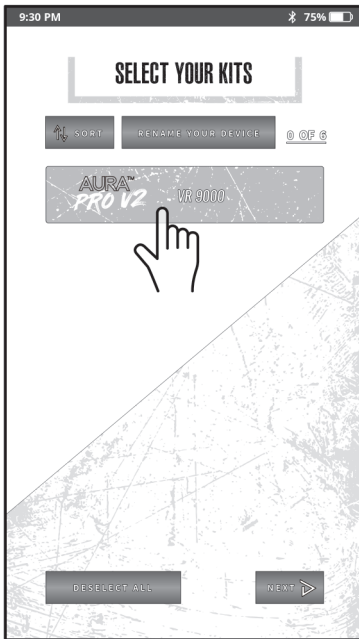

## STEP 2 ADD DEVICE

Tap "Device" to pair and connect. Once connected, tap "NEXT" to access the menu.



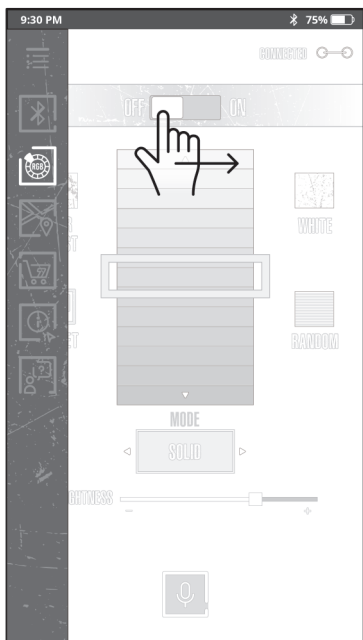

## STEP 3 APP CONTROL

Slide "ON/OFF" bar to the right to turn on the lights.

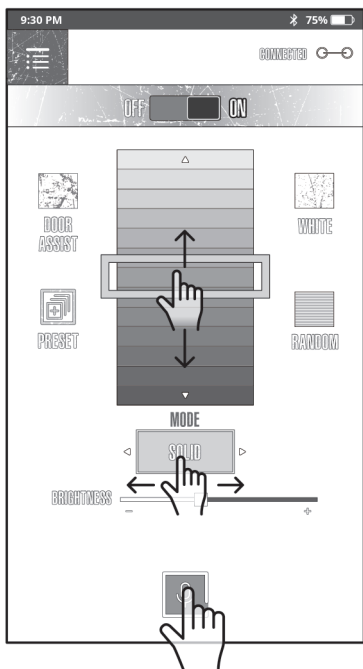

## STEP 4 COLOR AND STYLE SELECTION

Start picking colors and styles you like.

- 1 By Scroll Color bar and swipe Style Mode
- 2 By voice control

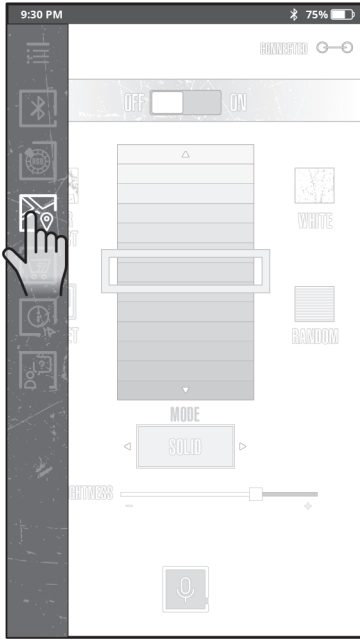

## STEP 5 NAVIGATION MODE

Tap "Navigation". Then, you will be directed to the map screen.



## STEP 6 NAVIGATION LIGHT SETTINGS

Tap "Light Settings" to create a custom settings for turn signals and speed limits alerts.

\* If you choose "default mode", you can skip steps 6,7,8 and go directly to step 9

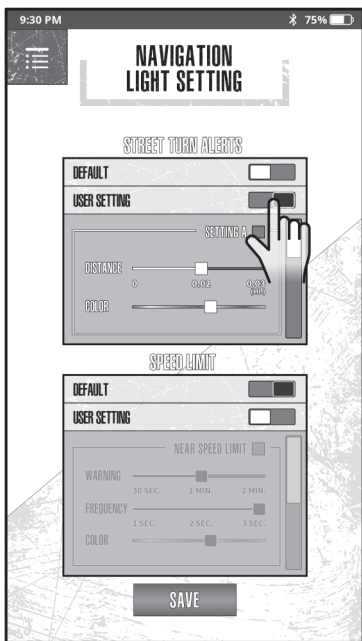

## STEP 7 STREET TURN ALERTS SETTING

Tap "User Setting" to create your own **DISTANCES AND COLORS**.

\*Scroll down for up to 3 settings selections.

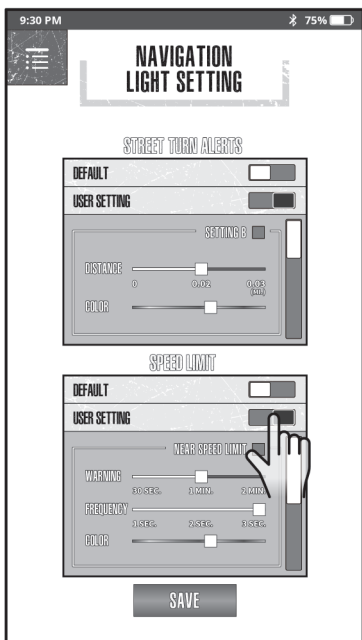

## STEP 8 SPEED LIMIT SETTING

Tap "User Setting" to create your own **WARNING, FREQUENCY, AND COLORS**.

\*Scroll down to view up to 2 settings.

When you are finished, tap "Save". It will take you back to the map screen.

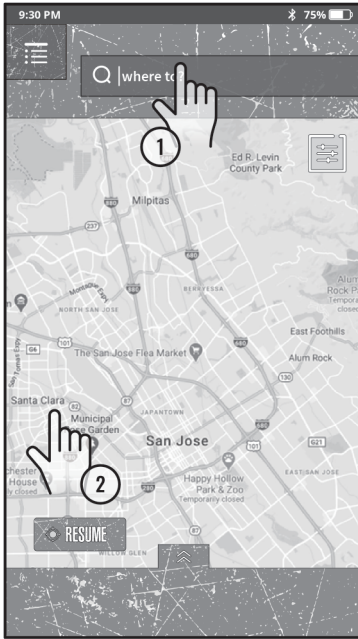

## STEP 9 FIND YOUR TRIPS

There are 2 ways to input your destination.

- 1 Tap "Search Bar" to enter the full address (\*or choose from your favorites.)
- 2 Zoom in to find your desired location. Press and hold to pin a spot on the map to set it up.

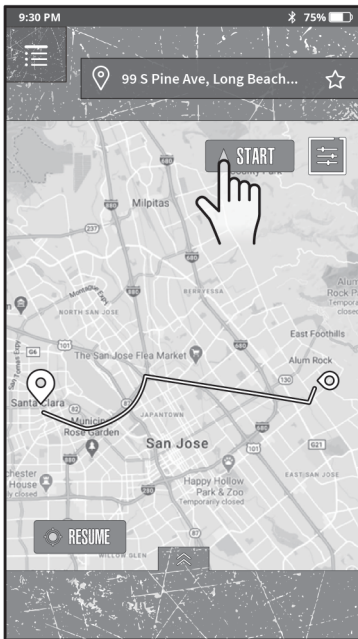

## STEP 10 START NAVIGATION

Once you have entered the destination address, the map will show you the best route. Then, tap "Start" to activate the map navigation.

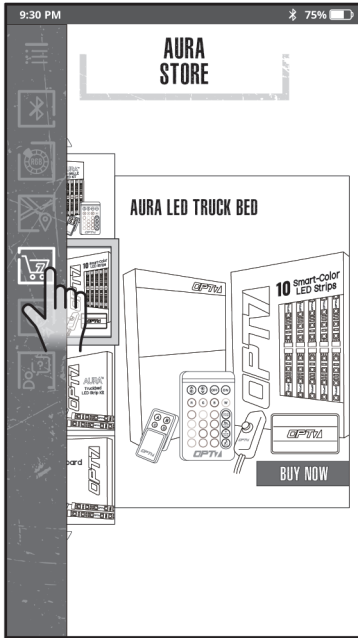

## | STORE MODE

Tap "Store" to go to OPT7 Store to shop OPT7/AURA products.

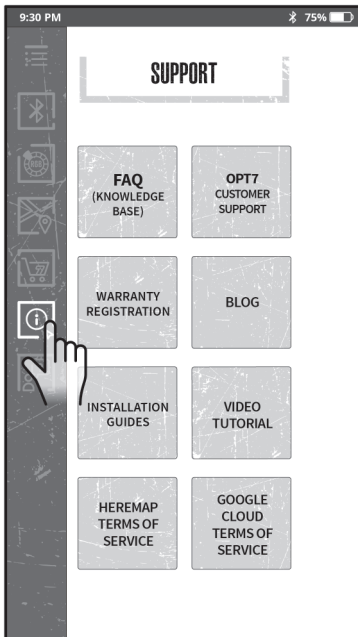

## | OPT7 SUPPORT

Tap "OPT7 SUPPORT" to find OPT7 Support, Knowledge Base, Install Guides and videos...etc.

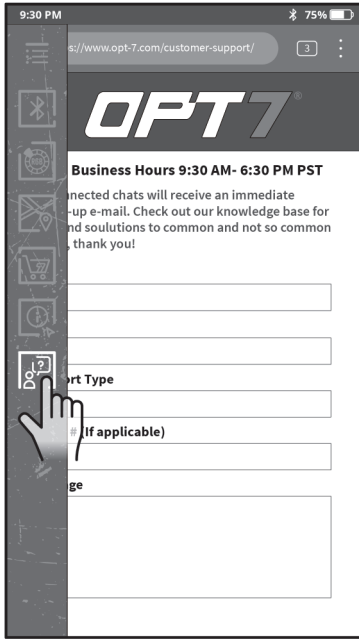

## | CUSTOMER SERVICE

Tap "LIVE CHAT" to chat with our customer service.