

AURA™ GLOW DREAMCOLOR UNDERGLOW

INSTALLATION GUIDE

MAIN COMPONENTS



A RIGID LIGHT BARS 1×36" (TWO-SECTION MOVABLE 18")



B RIGID LIGHT BARS 2×48" (TWO-SECTION MOVABLE 24")



C RIGID LIGHT BARS 2×18"

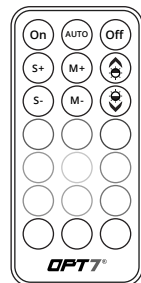
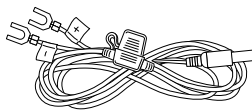

CONTROL BOX (SCAN QR CODE FOR APP USER GUIDE)

HARDWIRE POWER HARNESS

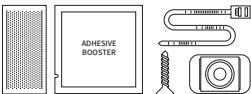

INCLUDES -
WIRE MOUNTS,
SELF-TAPPING SCREWS,
BOOSTER, VELCRO, ZIP TIES

MOUNTING KIT

HAND HELD REMOTE

INSTALLATION

STEP 1 Inspect the kit has all the contents included and power the unit to test the lights function properly with the 12 volt adapter provided.

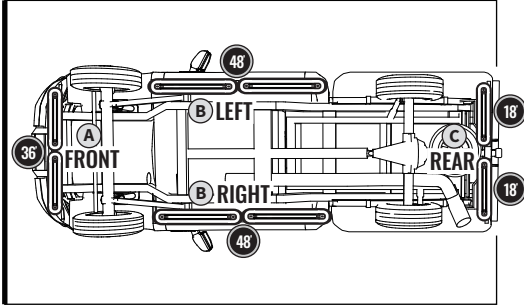

STEP 2

Decide where to locate the control box and ensure wiring has enough length for light bars to be installed in desired location.

IMPORTANT:
Avoid installation areas of the engine bay + heated surfaces.

As shown below, connect all the LED bars to the control box.

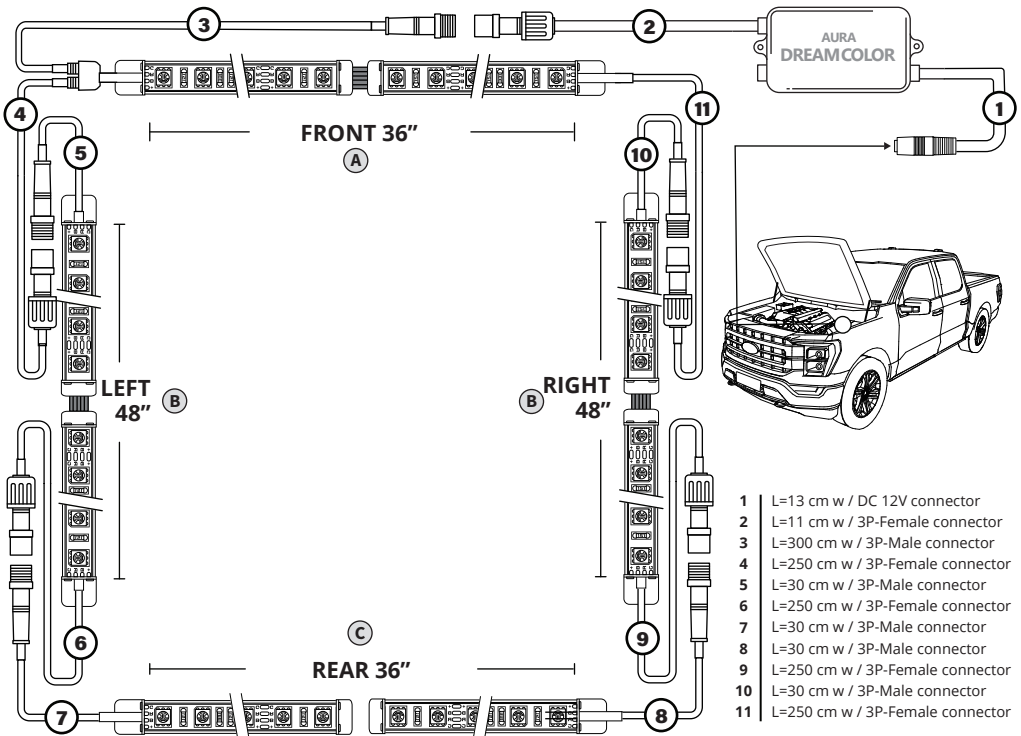

INSTALLATION

⚠ IMPORTANT ⚠

**BE SURE TO CONFIRM THE CORRECT DIRECTION OF THE ARROW!!
TO AVOID PRODUCT DAMAGE DUE TO INCORRECT INSTALLATION.**

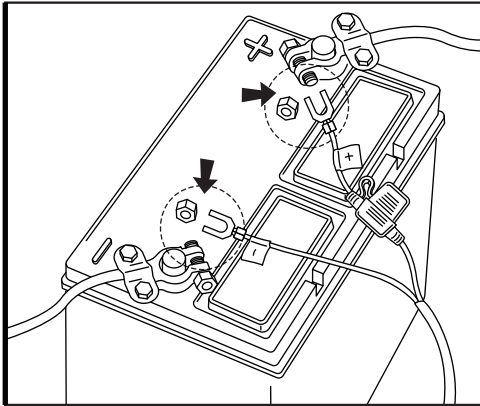
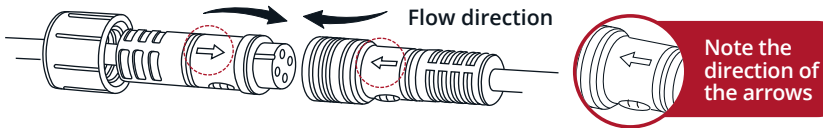

| HOW TO CONNECT POWER HARNESS TO YOUR VEHICLE

- Connect the Red wire (+) of power harness to the vehicle battery's positive terminal.
- Connect the Black wire (-) of power harness to the vehicle battery's negative terminal or an unpainted area on your vehicle's frame.



WARNING

1. Connecting to more than 10 AMP will override the kit and cause early failure, ensure it is 10 AMP or less!!
2. Please ensure that the LED bars or strips/control box/wiring all are mounted in areas where will not exceed 85°C or 185°F.

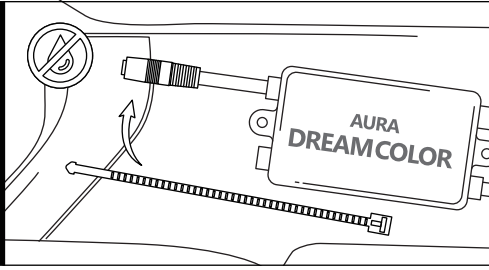

STEP 3

Secure Control box in desired location with Velcro or zipties.

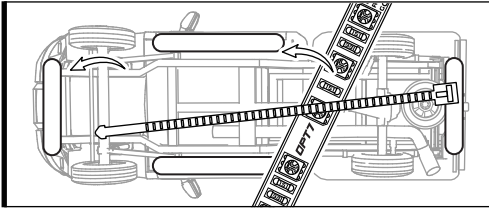

STEP 4

Secure the light bars using the zip ties to tie all the wiring away from the moving components.

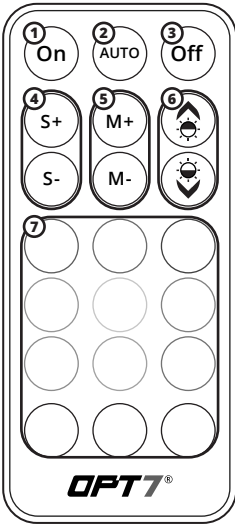

STEP 5

Using the included 21Key E-Z Remote, select your desired color or pattern.

- 1 Power-ON
- 2 Automatic Color Change
- 3 Power-OFF
- 4 Speed +/- 10 evels
- 5 Mode +/- 24 Mode
- 6 Dimmer 10 Levels
- 7 Color Selection 12 Colors

NOTE: When you use this product, keep it within 10m/33ft as much as possible.

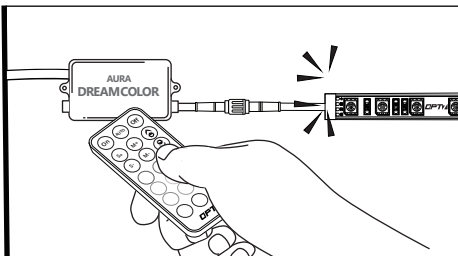

HOW TO PAIR THE REMOTE?

Pair the Device:

To pair the remote, reconnect the power, then aim the remote at the control box and hold the ON button until the LED strips flash white.

Unpair the Device:

To unpair the remote, reconnect the power, then aim the remote at the control box and hold the OFF button until the LED strips flash white.

QR CODE TO DOWNLOAD



Download the free "OPT7 GLOW" App

- App iOS (12+) available on App Store
- Android (8+) available on Google Play

| STEP 6

Download the OPT7 GLOW to have the best experience.



Please scan to see the OPT7 GLOW user guide.

<https://wintis.ladesk.com/362302-OPT7-AURA-Glow-Application-User-Guide>

DISCLAIMER

OPT7 Lighting is not liable for damages or personal injuries while installing this product. The Installation Guide is intended as assistance to reduce setup time.

OPT7 Lighting assumes no responsibility for improper installation.

If you are unfamiliar with your vehicle or inexperienced with aftermarket upgrades, please seek professional assistance.

OPT7 recommends installation for safety and guidance.

Modified installations or installation recommendations not specified by OPT7 Lighting will void product warranty.