

**OPT7<sup>®</sup>**

# PHOTON

**WHITE** ROCK LIGHTS

INSTRUCTION MANUAL

*+MAGNET*

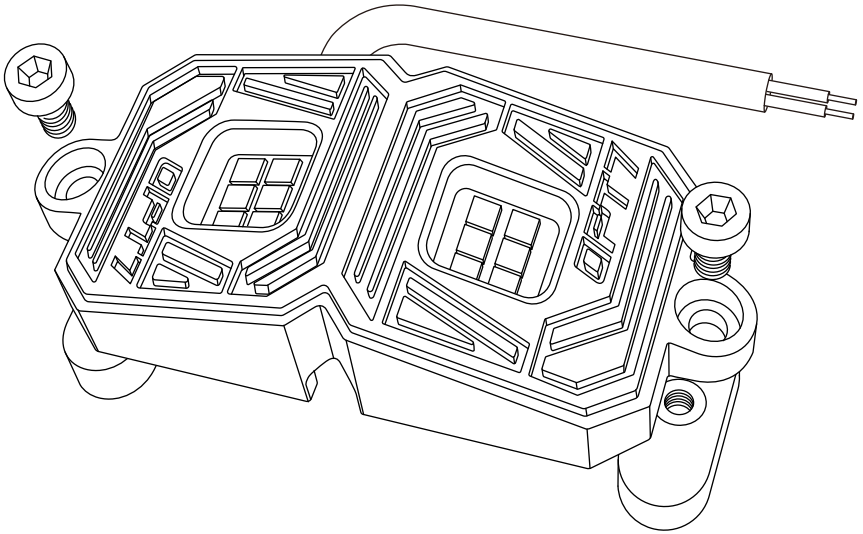

## SPECIFICATIONS

Input Voltage	DC 12V
Input Power	Max 2.4Watts per pod
LED Color	12pcs - White per pod
Raw Lumens	1100 LM (8 Pods Combined)
Waterproof	IP68 (Only Pod)
Operating Temperature	-5°F - 120°F

# MAIN COMPONENTS

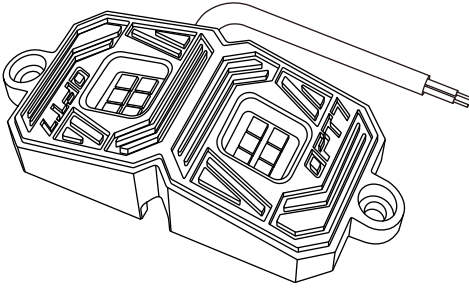

8 X PHOTON WHITE  
ROCK LIGHT POD

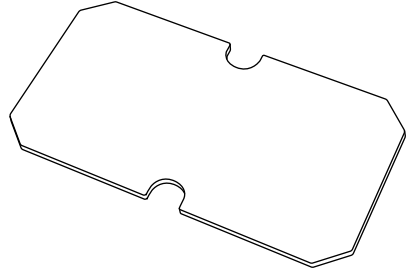

8 X VHB DOUBLE SIDED  
ADHESIVE TAPE

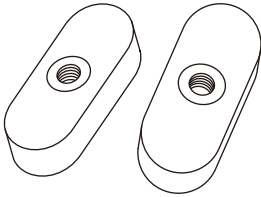

16 X HIGH QUALITY  
MAGNETS

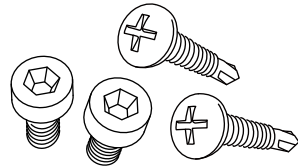

32 X MOUNTING SCREWS

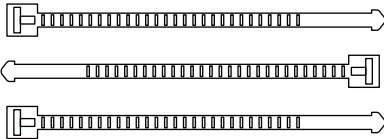

30 X ZIP-TIE

# INSTALLATION

## STEP 1

Inspect kit to ensure all contents was included. Then decide where to locate the control box and ensure wiring has enough length for the rock lights to be installed in the desired location.

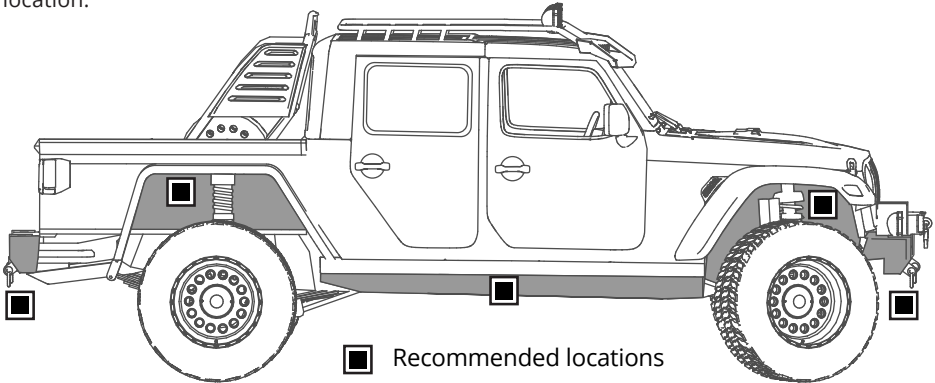

## OPTION METHODS

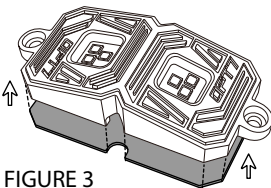
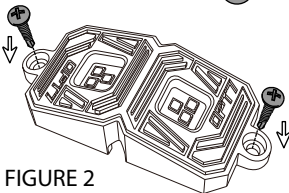
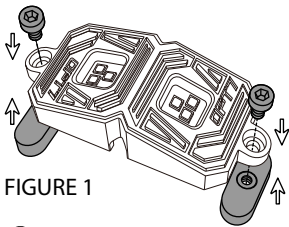

There are 3 installation methods, you can refer to the following methods to install and choose the best method for your vehicle.

### OPTION 1

Use "Strong Magnets" for mounting as shown in Fig. 1

### OPTION 2

Use "Self-Drilling Screws" for mounting as shown in Fig. 2

### OPTION 3

Use "VHB Double-Sided Adhesive" for mounting as shown in Fig. 3

#### IMPORTANT

1. Before starting installation, we recommend that all rock light pods be checked to ensure that all functions are working properly.
2. Avoid hot surfaces and / or moving parts.

## STEP 2

Find a constant 12-volt power source to power the rock lights. For details refer to the instructions below:

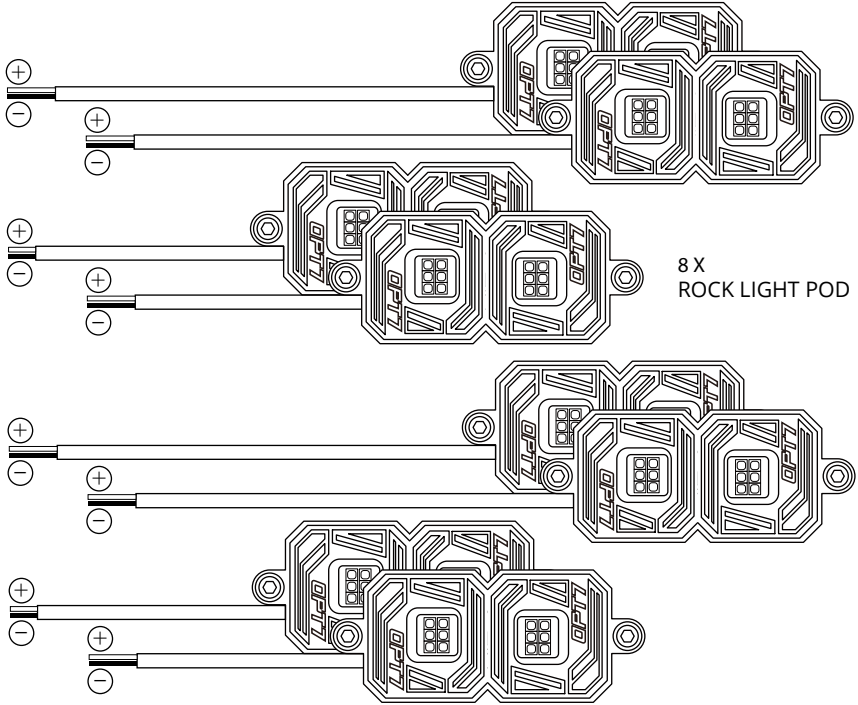

- Connect the positive(+) wire to the positive post (+) of the battery.
- Connect the negative(-) wire to the negative post (-) of the battery or to a common Ground location.

### CAUTION

1. Start installing the LED Pods onto your vehicle. If any excess wiring are exposed during installation process, you must use the zip-ties to securely tie them together and tuck the wire into the junction area to avoid snagging or damage wires.
2. Rock Light Pods become extremely hot during use-keep away from any vehicle parts that may be damaged by exposure to high temperatures.
3. Avoid installation areas of the engine bay + heated surfaces.

# OPTION

## **OPT7 ROCK LIGHTS 5 PIN ON/OFF ROCKER SWITCH WITH JUMPER WIRES**

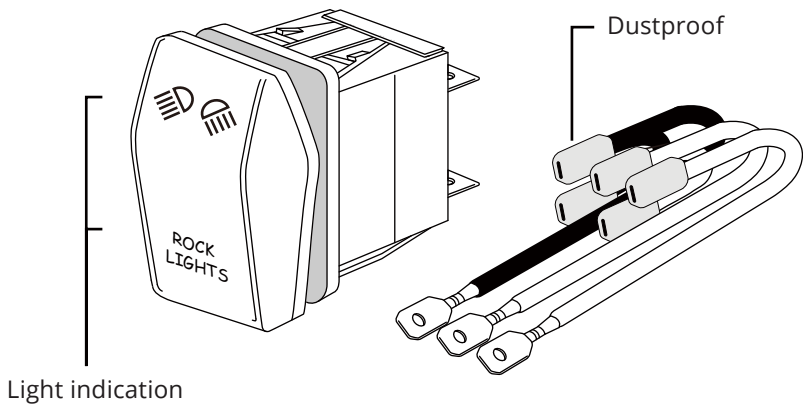

## **EASY TO CONTROL**

OPT7 Rock Lights 5-Pin ON/OFF Rocker Switch with Jumper Wires are designed to turn on/off the Photon Rock Lights easier.

Light Indication Design: Easy to operate and locate in plain sight or darkness.

Dustproof Design: Avoid dust cluttering rocker switch

Buy it now only on OPT7 Lighting!

**OPT7**



If you are uncomfortable performing work of this nature yourself, then do not hesitate to consult a professional for help. Working with a vehicle's electrical system can be hazardous to an unqualified individual. OPT7 is not liable for damages or personal injuries while installing this product. The installation guide is provided as assistance to reduce set up time.

# DISCLAIMER

OPT7 Lighting is not liable for damages or personal injuries while installing this product. The Installation Guide is intended as assistance to reduce setup time. OPT7 Lighting assumes no responsibility for improper installation. If you are unfamiliar with your vehicle or inexperienced with aftermarket upgrades, please seek professional assistance.