

OPT7[®]

PHOTON

GLOW RGB ROCK LIGHTS

INSTRUCTION MANUAL

+MAGNET

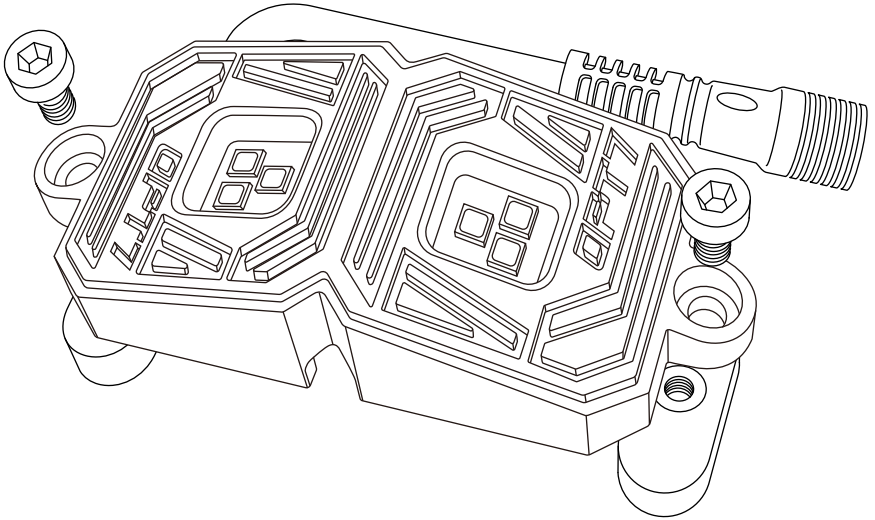

SPECIFICATIONS

Input Voltage	DC 12V
Input Power	Max 9 Watts per pod
LED Color	6pcs - RGB per pod
Raw Lumens	1200 LM (8 Pods Combined)
Waterproof	IP68
Operating Temperature	-5°F - 120°F

MAIN COMPONENTS

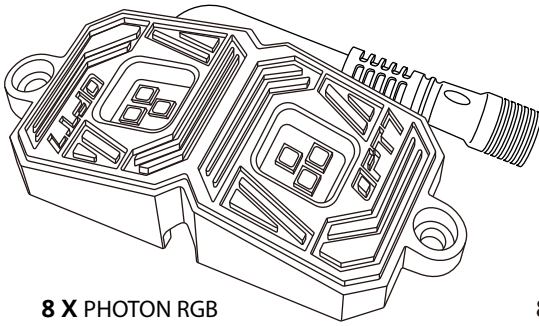

**8 X PHOTON RGB
ROCK LIGHT POD**

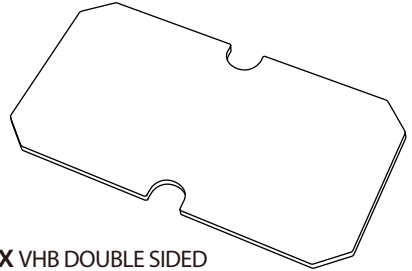

**8 X VHB DOUBLE SIDED
ADHESIVE TAPE**

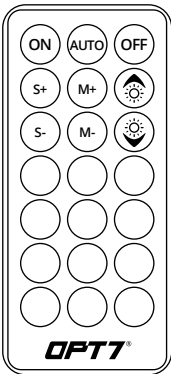

EZ-REMOTE

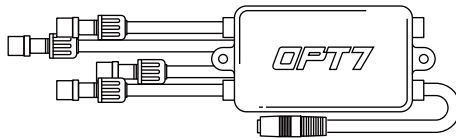

CONTROL BOX (SCAN QR CODE FOR APP USER GUIDE)

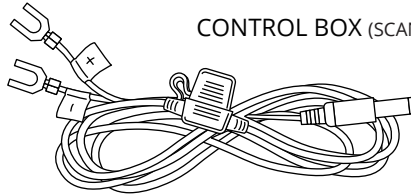

1 X HARDWIRE POWER HARNESS

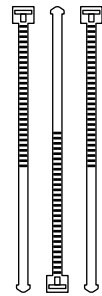

30 X ZIP-TIE

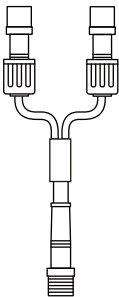

4 X Y-SPLITTER



8 X 10FT EXTENSION WIRE

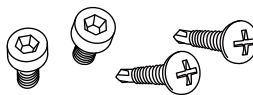

32 X MOUNTING SCREWS

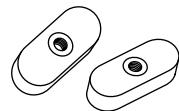

**16 X HIGH QUALITY
MAGNETS**

INSTALLATION

STEP 1

Inspect kit to ensure all contents was included. Then decide where to locate the control box and ensure wiring has enough length for the rock lights to be installed in the desired location.

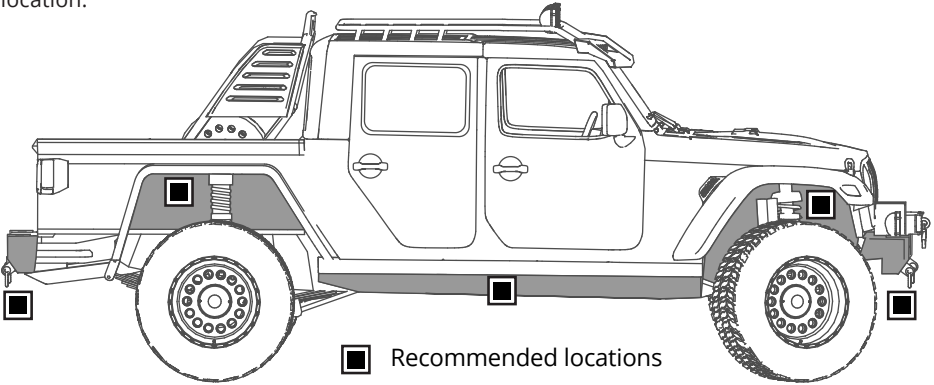

OPTION METHODS

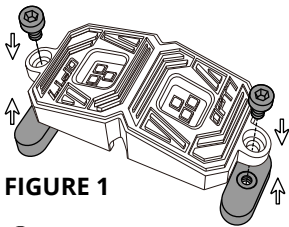

There are 3 installation methods, you can refer to the following methods to install and choose the best method for your vehicle.

OPTION 1

Use "Strong Magnets" for mounting as shown in Fig. 1

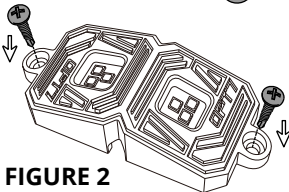

OPTION 2

Use "Self-Drilling Screws" for mounting as shown in Fig. 2

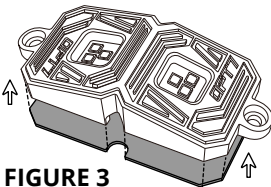

OPTION 3

Use "VHB Double-Sided Adhesive" for mounting as shown in Fig. 3

IMPORTANT

1. Before starting installation, we recommend that all rock light pods be checked to ensure that all functions are working properly.
2. Avoid hot surfaces and / or moving parts.

STEP 2

As show below, connect all the Rock Light Pods to the control box with the included extension wires.

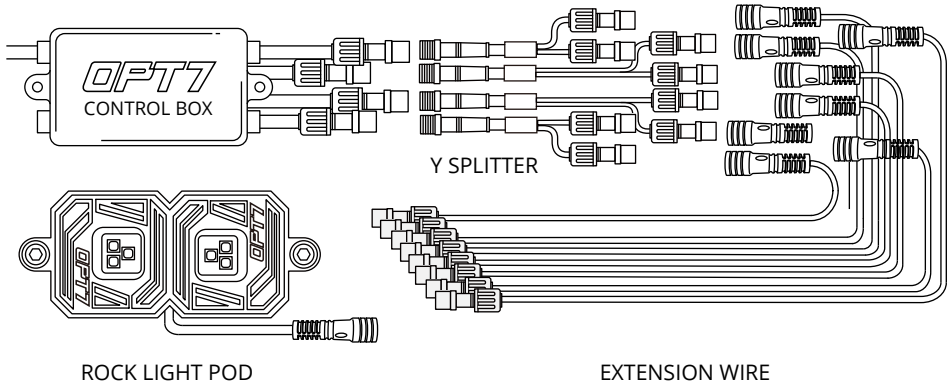

⚠ IMPORTANT ⚠

**BE SURE TO CONFIRM THE CORRECT DIRECTION OF THE ARROW!!
TO AVOID PRODUCT DAMAGE DUE TO INCORRECT INSTALLATION.**

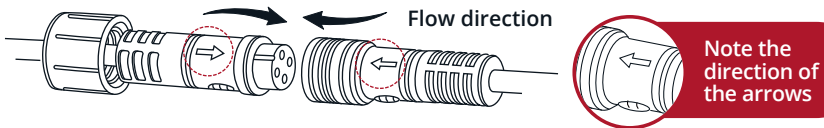

CORRECT INSTALLATION

⚠ CAUTION

1. Start installing the LED Pods onto your vehicle. If any excess wiring are exposed during installation process, you must use the zip-ties to securely tie them together and tuck the wire into the junction area to avoid snagging or damage wires.
2. Rock Light Pods become extremely hot during use-keep away from any vehicle parts that may be damaged by exposure to high temperatures.
3. Avoid installation areas of the engine bay + heated surfaces.

STEP 3

Find a constant 12-volt power source to power the rock lights. For details refer to the instructions below:

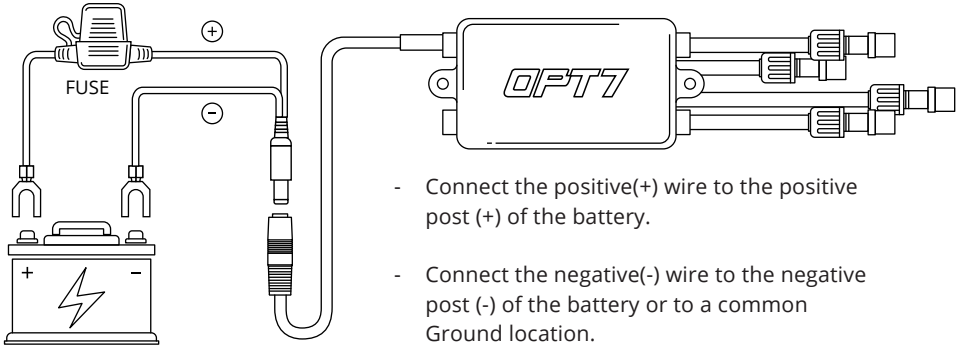

WARNING

1. Connecting to more than 10 AMP will override the kit and cause early failure, ensure it is 10 AMP or less!!
2. Please ensure that the LED pods, control box and wiring all are mounted in areas where will not exceed 85°C or 185°F.

STEP 4

Using the included E-Z Remote, select your desired color or pattern.

BUTTON LAYOUT

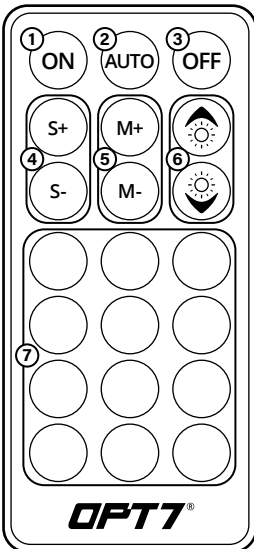

- | | |
|---|----------------------------------|
| 1 | Power-ON |
| 2 | Automatic Color Change |
| 3 | Power-OFF |
| 4 | Speed +/- 8 Levels |
| 5 | Mode +/- 19 Mode |
| 6 | Dimmer 8 Levels |
| 7 | Color Selection 12 Colors |

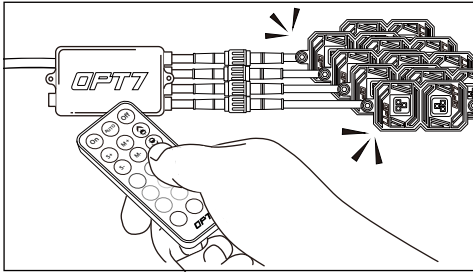

HOW TO PAIR THE REMOTE?

Pair the Device:

To pair the remote, reconnect the power, then aim the remote at the control box and hold the ON button until the LED strips flash white.

Unpair the Device:

To unpair the remote, reconnect the power, then aim the remote at the control box and hold the OFF button until the LED strips flash white.

QR CODE TO DOWNLOAD



SCAN FOR APP

OPT7®
GLOW



Download the free "OPT7 GLOW" App

- App iOS (12+) available on App Store
- Android (8+) available on Google Play

STEP 7

Download the OPT7 GLOW to have the best experience.



Please scan to see the OPT7 GLOW user guide.

<https://wintis.ladesk.com/362302-OPT7-AURA-Glow-Application-User-Guide>



If you are uncomfortable performing work of this nature yourself, then do not hesitate to consult a professional for help. Working with a vehicle's electrical system can be hazardous to an unqualified individual. OPT7 is not liable for damages or personal injuries while installing this product. The installation guide is provided as assistance to reduce set up time.

DISCLAIMER

OPT7 Lighting is not liable for damages or personal injuries while installing this product. The Installation Guide is intended as assistance to reduce setup time. OPT7 Lighting assumes no responsibility for improper installation. If you are unfamiliar with your vehicle or inexperienced with aftermarket upgrades, please seek professional assistance.

OPT7